

RoHS Compliant and Pb-Free Product  
Package: S-20

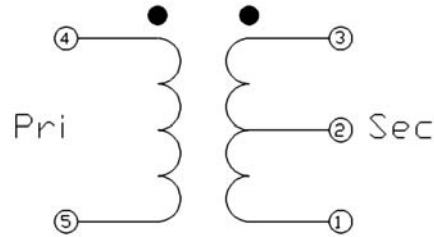

Schematic

### Features

- Frequency Range 1 -350MHz
- Low Cost and RoHS Compliant
- Flux Coupled
- Industry Standard SMT package
- Available in Tape-and -Reel
- 50Ω Characteristic Impedance

### Applications

- Broadband
- Wireless Communications

### Product Description

The RFXF2553 transformer is designed for applications that require very small, low cost, and highly reliable surface mount components. Applications may be found in broadband, wireless, and other communications systems. These units are built Lead-Free and RoHS compliant. S-Parameters are available on request.

Parameter	Specification			Unit	Condition
	Min.	Typ.	Max.		
Typical values represent Mid-Band performance at 25 °C					
Frequency	1		350	MHz	
Insertion Loss <1 dB	1		350	MHz	
Insertion Loss <2 dB	-		-	MHz	
Insertion Loss <3 dB	-		-	MHz	
Amplitude Balance		0.2	0.5	dB	
Phase Balance		2	5	°	
Impedance Ratio	1:4				
Type	Unbalanced to Balanced				

### Absolute Maximum Ratings

Parameter	Rating	Unit
RF Power	2	W
Operating Temperature	-40 to +85	°C
Storage Temperature	-55 to +100	°C



**Caution!** ESD sensitive device.

Exceeding any one or a combination of the Absolute Maximum Rating conditions may cause permanent damage to the device. Extended application of Absolute Maximum Rating conditions to the device may reduce device reliability. Specified typical performance or functional operation of the device under Absolute Maximum Rating conditions is not implied.

RoHS status based on EUDirective2002/95/EC (at time of this document revision).

The information in this publication is believed to be accurate and reliable. However, no responsibility is assumed by MiniRF, Inc. ("MiniRF") for its use, nor for any infringement of patents, or other rights of third parties, resulting from its use. No license is granted by implication or otherwise under any patent or patent rights of MiniRF. MiniRF reserves the right to change component circuitry, recommended application circuitry and specifications at any time without prior notice.

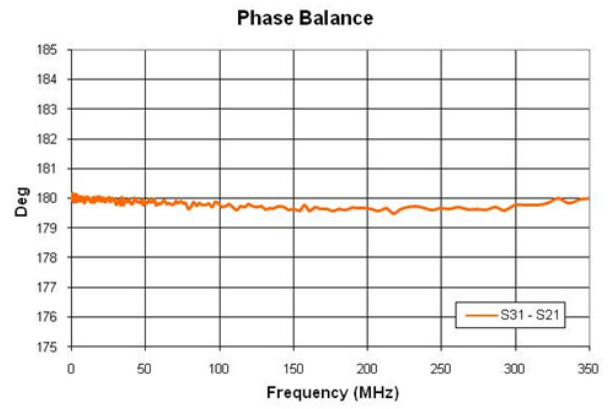
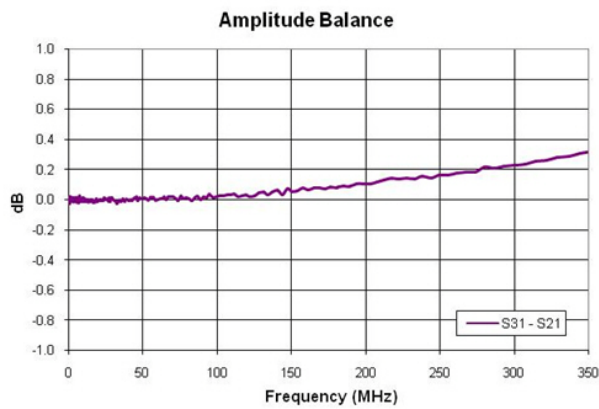
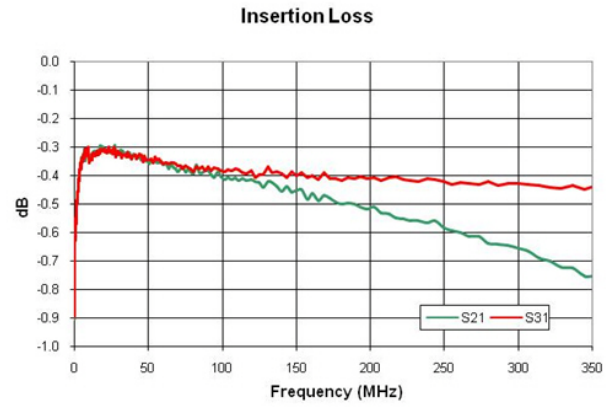
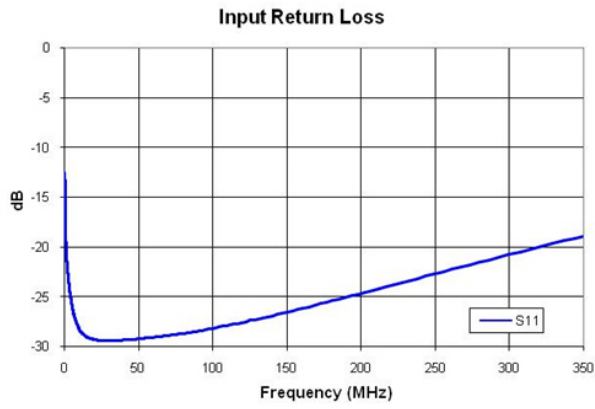

### Pin Out

Pin	Function
1	Secondary
2	Secondary CT
3	Secondary Dot
4	Primary Dot
5	Primary

### S20 Package Drawing

Dimensions in inches (millimeters)

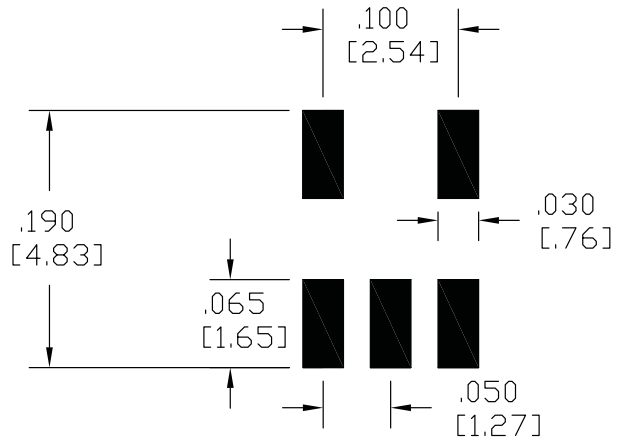
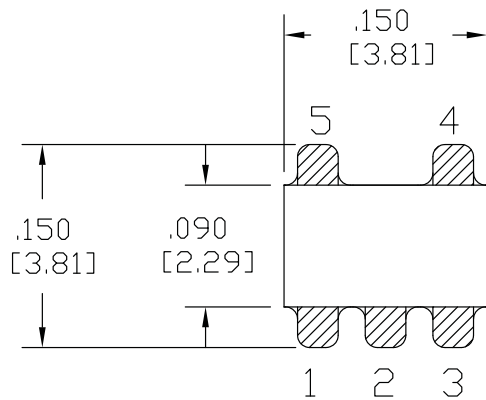

### PCB FOOTPRINT

