

RoHS Compliant and Pb-Free Product
Package: S20

Features

- Frequency Range: 5 MHz to 1200MHz
- Low Cost and RoHS Compliant
- Industry Standard SMT package
- Available in Tape-and -Reel
- 75Ω Characteristic Impedance



Product Description

The RFCP5743 Coupler is designed for applications that require small, low cost, and highly reliable surface mount components. Applications may be found in broadband, wireless, and other communications systems. These units are built Lead-Free and RoHS compliant. S-Parameters are available on request.

Specifications

Parameter	Specification			Unit
	Min.	Typ.	Max.	
Frequency Range	5		1200	MHz
Nominal Coupling	9.5	10	10.5	dB
Coupling Flatness	-0.5		+0.5	dB
Insertion Loss		1.5	2.0	dB
Directivity	8	14		dB
Return Loss	14	17		dB
Nominal Impedance	75			Ω

Note: Typical values represent Mid-band performance at 25 °C.

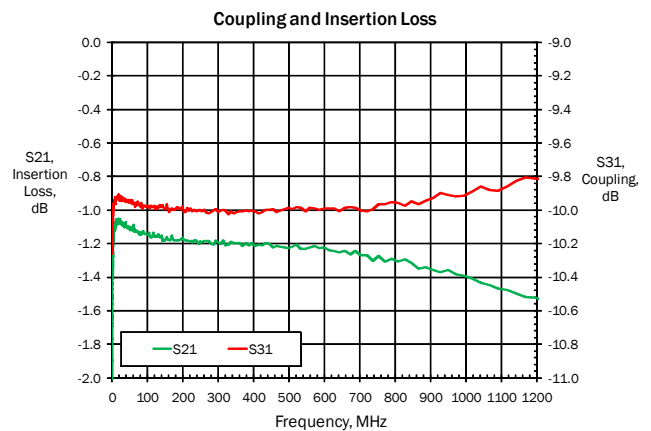
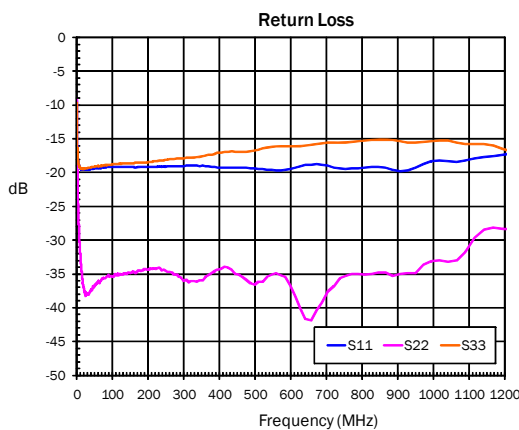
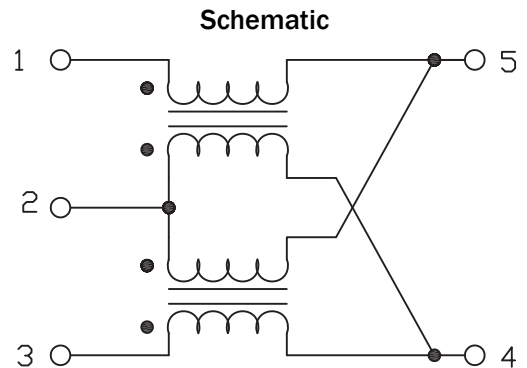

RFCP5743

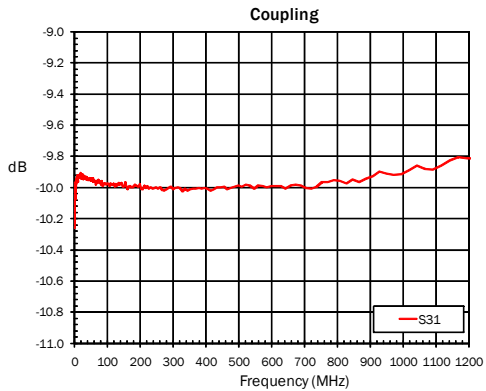
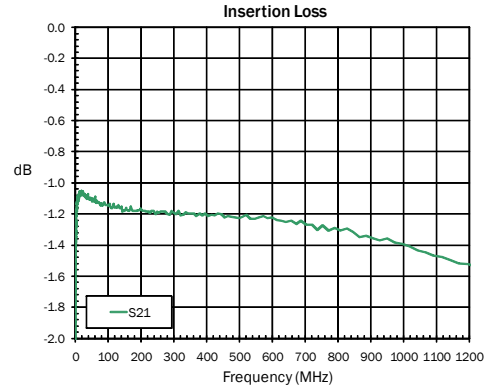
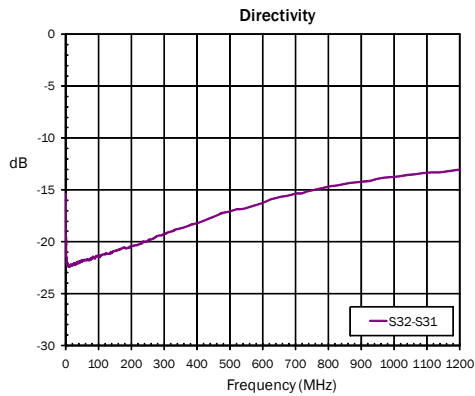

Pin Out

Pin	Name
1	Input
2	Ground
3	Coupled
4	Terminated
5	Output

Absolute Maximum Ratings

Parameter	Rating	Unit
RF Power	2	W
Operating Temperature	-40 to +85	°C
Storage Temperature	-55 to +100	°C

S20 Package Drawing

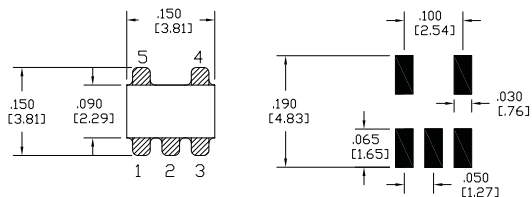

PCB FOOTPRINT

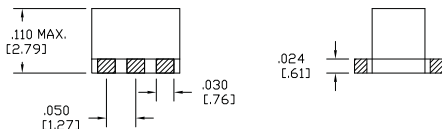

Exceeding any one or a combination of the Absolute Maximum Rating conditions may cause permanent damage to the device. Extended application of Absolute Maximum Rating conditions to the device may reduce device reliability. Specified typical performance or functional operation of the device under Absolute Maximum Rating conditions is not implied.

RoHS status based on EU Directive 2002/95/EC (at time of this document revision).

The information in this publication is believed to be accurate and reliable. However, no responsibility is assumed by MiniRF, Inc. ("MiniRF") for its use, nor for any infringement of patents, or other rights of third parties, resulting from its use. No license is granted by implication or otherwise under any patent or patent rights of MiniRF. MiniRF reserves the right to change component circuitry, recommended application circuitry and specifications at any time without prior notice.