

RoHS Compliant and Pb-Free Product
Package: S04

Features

- Frequency Range: 5 MHz to 200MHz
- Low Cost and RoHS Compliant
- Industry Standard SMT package
- Available in Tape-and -Reel
- 75Ω Characteristic Impedance



Product Description

The RFSP2731 Splitter is designed for Broadband/CATV applications that require small, low cost, and highly reliable surface mount components. These units are built Lead-Free and RoHS compliant. S-Parameters are available on request.

Specifications

Parameter	Specification			Unit
	Min.	Typ.	Max.	
Frequency Range	5		200	MHz
Insertion Loss		0.35	0.6	dB
Isolation	25	30		dB
Input Return Loss	23	40		dB
Output Return Loss	21	30		dB
Amplitude Balance		0.1	0.2	dB
Phase Balance		1.0	5.0	°

Note: Typical values represent midband performance at T=25 °C.

Schematic

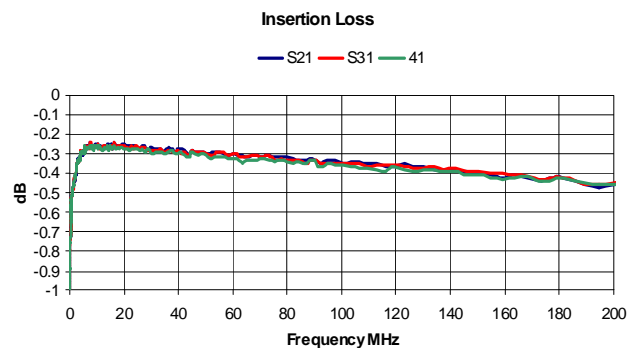
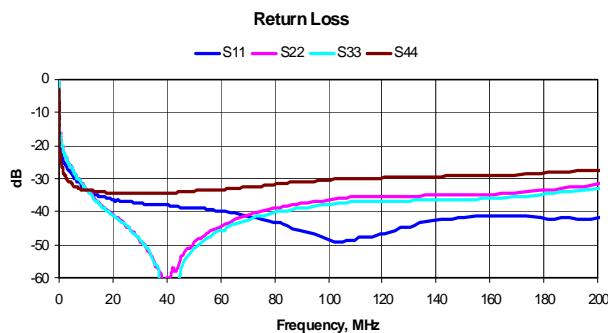
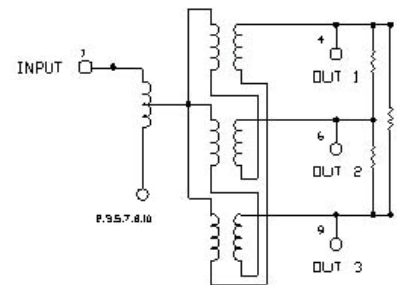

RFSP2731



Amplitude Balance

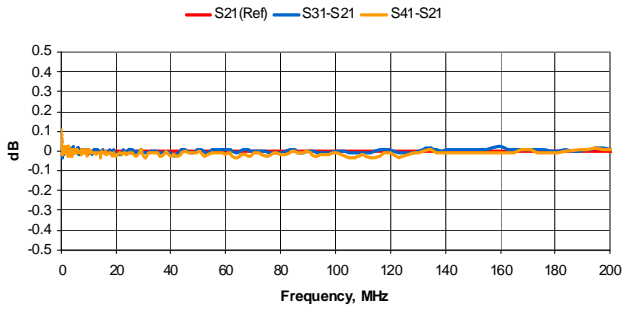

Phase Balance

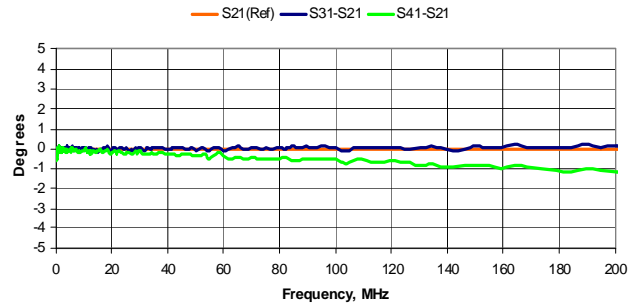

Return Loss

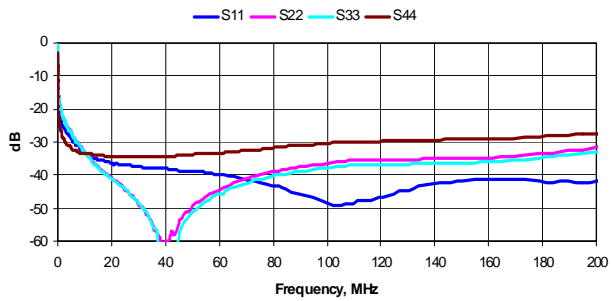

Isolations

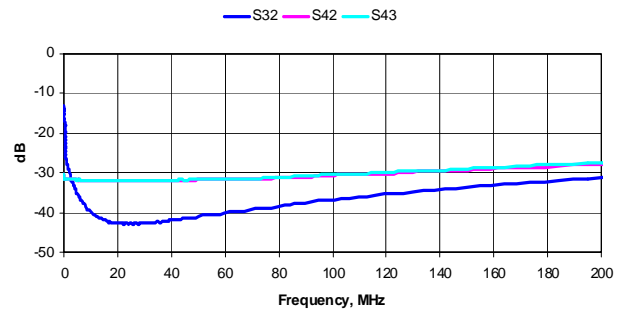

Pin Out

Pin	Name
1	Input
2, 3, 5, 7, 8, 10	Ground
4	Output 1
6	Output 2
9	Output 3

Absolute Maximum Ratings

Parameter	Rating	Unit
RF Power	+33	dBm
Operating Temperature	-40 to +85	°C
Storage Temperature	-55 to +100	°C

Package Drawing - S04

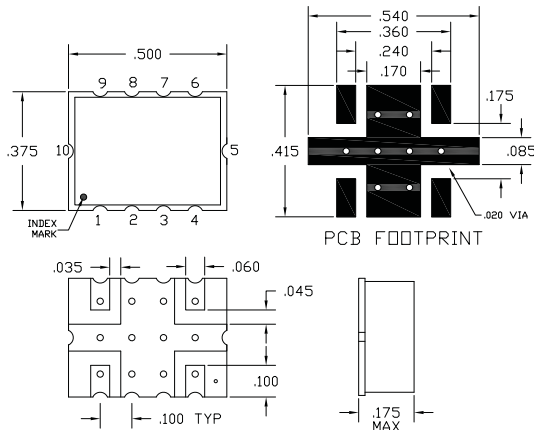

Exceeding any one or a combination of the Absolute Maximum Rating conditions may cause permanent damage to the device. Extended application of Absolute Maximum Rating conditions to the device may reduce device reliability. Specified typical performance or functional operation of the device under Absolute Maximum Rating conditions is not implied.

RoHS status based on EUDirective2002/95/EC (at time of this document revision).

The information in this publication is believed to be accurate and reliable. However, no responsibility is assumed by MiniRF, Inc. ("MiniRF") for its use, nor for any infringement of patents, or other rights of third parties, resulting from its use. No license is granted by implication or otherwise under any patent or patent rights of MiniRF. MiniRF reserves the right to change component circuitry, recommended application circuitry and specifications at any time without prior notice.